

RESMED

ApneaLink™

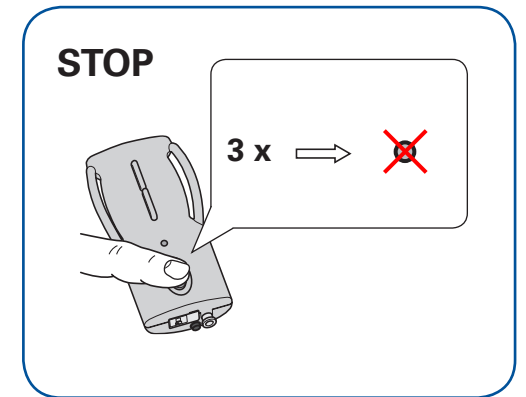
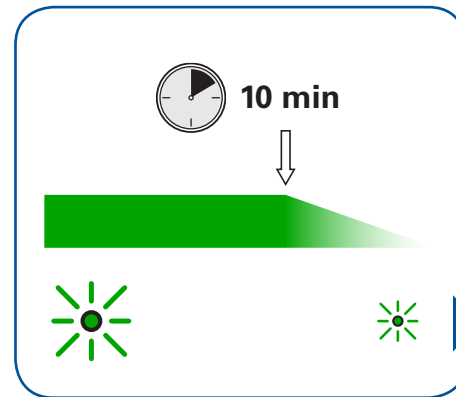
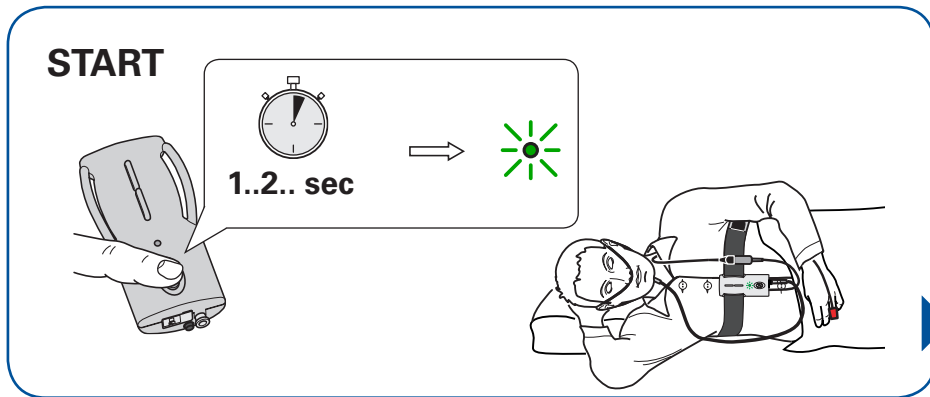
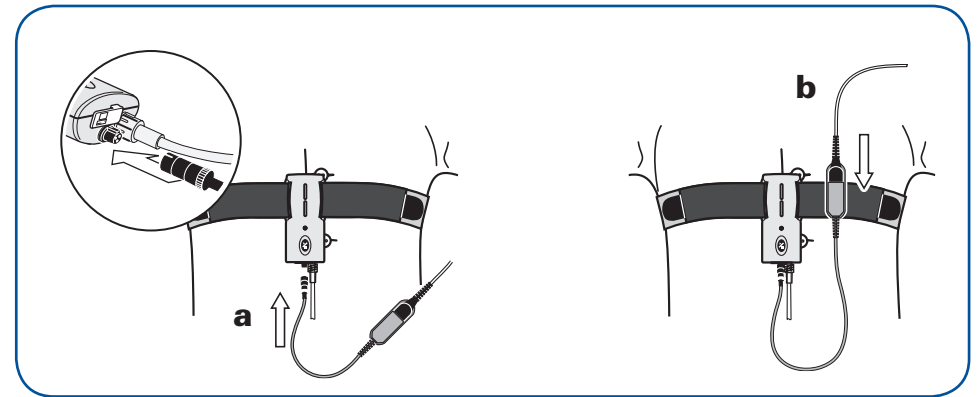
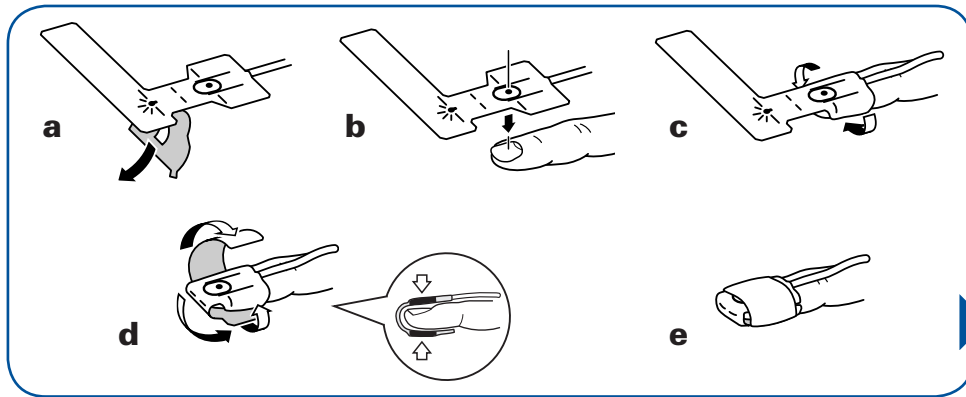
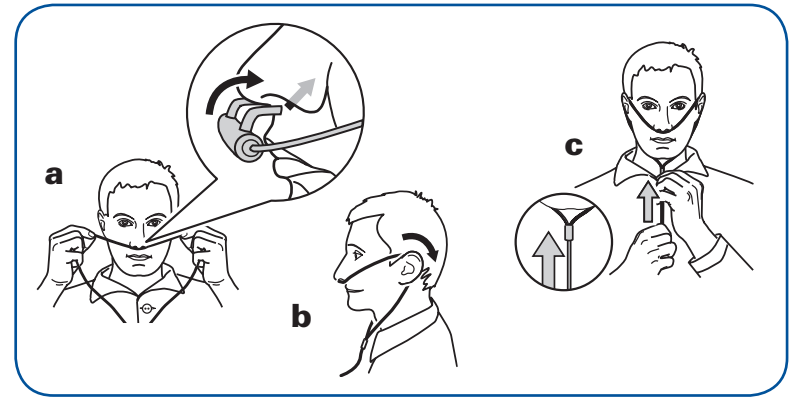
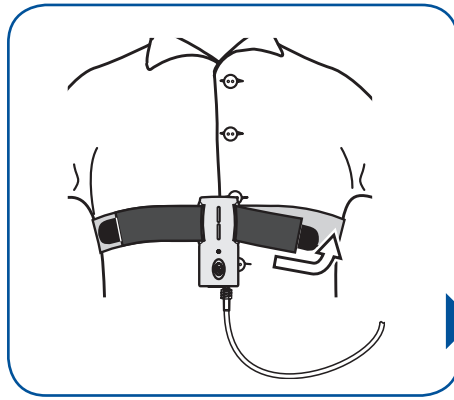
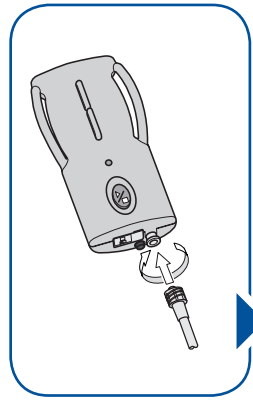

ResMed Germany Inc. (Manufacturer) Fraunhoferstr. 16 82152 Martinsried Germany ResMed Ltd (Manufacturer for Canada) 1 Elizabeth MacArthur Drive Bella Vista NSW 2153 Australia ResMed Corp (US Designated Agent) 14040 Danielson Street Poway CA 92064-6857 USA ResMed (UK) Ltd (EU Authorized Representative) 65 Milton Park Abingdon Oxfordshire OX14 4RX UK ResMed Offices Australia, Austria, Finland, France, Germany, Hong Kong, Japan, Malaysia, Netherlands, New Zealand, Singapore, Spain, Sweden, Switzerland, UK, USA (see www.resmed.com for contact details). Patents and designs pending. ApneaLink is a trademark of MAP Medizin-Technologie GmbH © 2007 ResMed Z28169/3 07 04